

Advanced Control for ZWARP

Biaxial wheel test bench

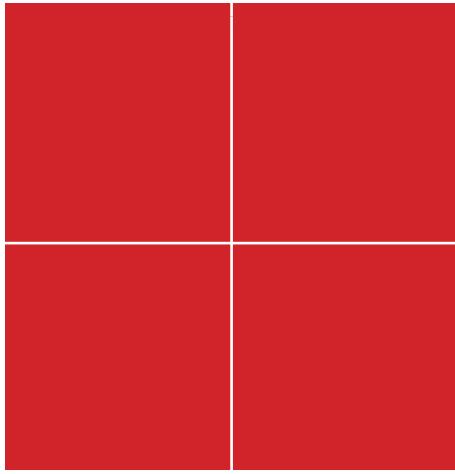

- Simple preparation of test profiles
- Comprehensive measured data recording integrated
- High safety standards
- Developed in cooperation with Fraunhofer LBF



The latest technology for ZWARP

The Fraunhofer Institute for Structural Durability and System Reliability LBF in Darmstadt has set standards with the development of the biaxial ZWARP wheel testing machines. The machines simulate the loads for road profiles and therefore enable the testing of wheels, wheel hubs or wheel bearings for cars, lorries, trailers or other special vehicles. Hagenbuch, as a specialist for hydraulic drive technology and regulation/control systems, developed a new generation of controls for Fraunhofer LBF, with which older machines can also be modernised.

Scarcely any other component bears as much responsibility as wheel. Good road adherence, safe acceleration and reliable driving dynamics are just a few of the important requirements for driving safety. The test procedures prescribed by law must be fulfilled in various areas.

Endurance testing by means of a biaxial wheel test bench (ZWARP) simulates the great loads that occur over the lifetime of a wheel. The biaxial load of the wheels, hubs and bearings is carried out in a rotating inner drum as a road simulation. The wheel is pressed against the running surface of the drum with the help of servo-hydraulic cylinders, ensuring the traction in the peripheral direction. The tire sidewall is corrected with wheel kinematics so that the resulting

force vector for all physical combinations of vertical and lateral forces corresponds to that of the real driving mode.

Good mechanics also comprise comprehensive controls with a high degree of functionality e.g. variable load direction and individual load amplitudes. A user-friendly interface and customer-specific adaptations accelerate the testing process.

Our motivation is to offer total solutions, which also include consultation and provision of aggregates, mechanical connections, safety concepts etc. Our engineers look forward to devising your new test bench with you.

Technical highlights:

- Complete systems incl. pressure supply and regulator
- Modernisation of older machines
- Pressure to max. 280 bar

ZWARP user interfaces test procedure

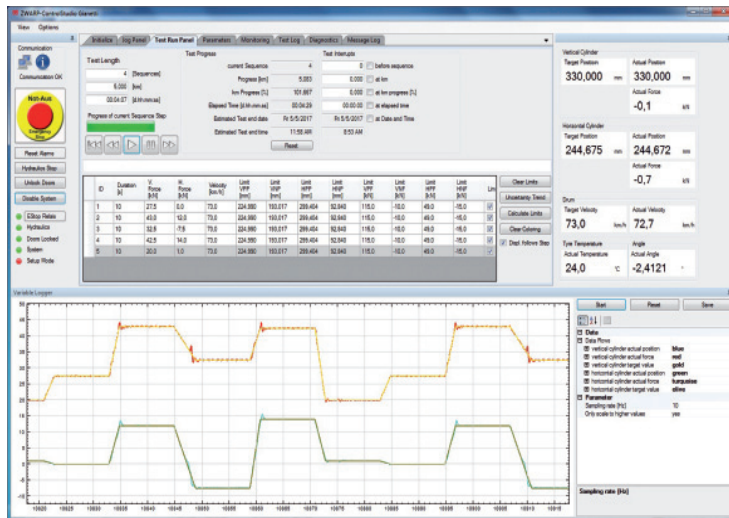

Test run

After loading a test procedure profile, various parameters can be defined, such as length (km), duration and number of test runs. This interface always shows the current status of the test. There is also the possibility to insert test interruptions, to check the test object or to re-tighten screws.

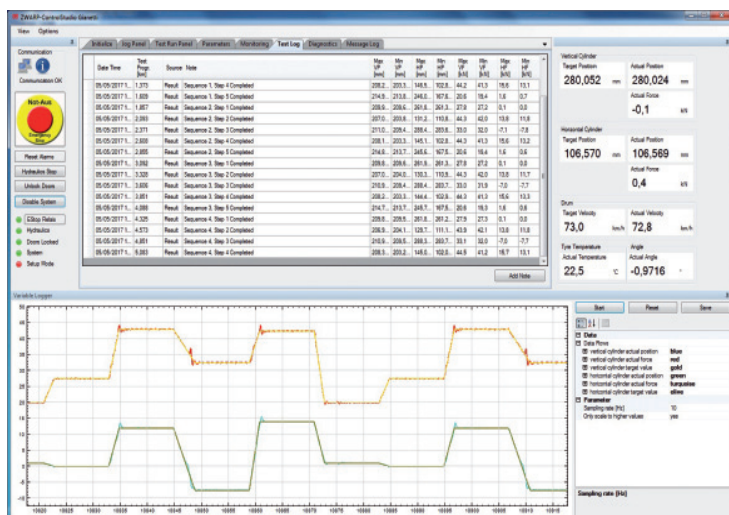

Test log

The test log summarises the defined load steps. It details the values of the load sequences (minimum and maximum), as well as the most important actions of the user. This logging shows the tendencies of the test object. All records in this table are entered into a file and can be printed.

ZWARP user interfaces

Analysis and monitoring tools

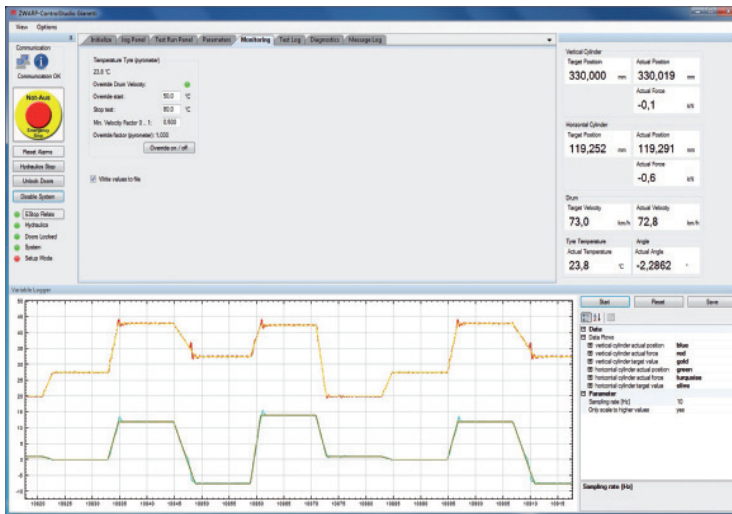

Monitoring

This interface serves to monitor the test object. Wheel temperature, air pressure, bearing and hub temperature can be defined, activated or deactivated. There are also control elements to set whether these values are to be entered into the log file.

The interface can be individually adapted to customer requirements.

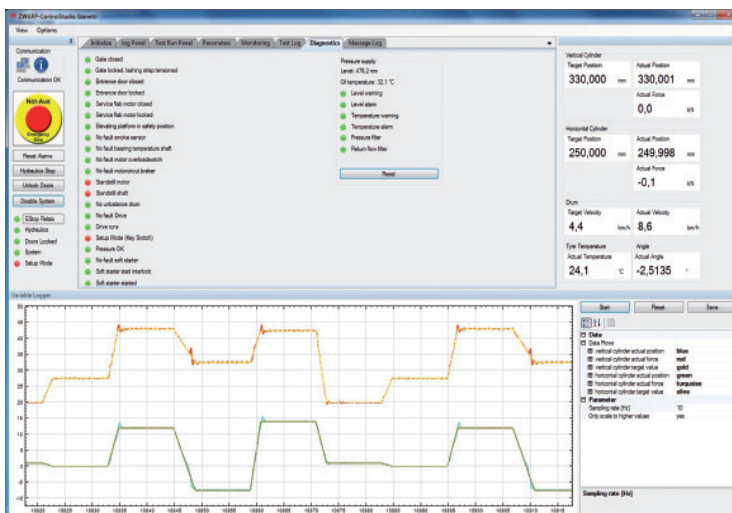

Diagnosis

The current status information with regard to the test bench is displayed here. This ensures that faults can be corrected without delay.

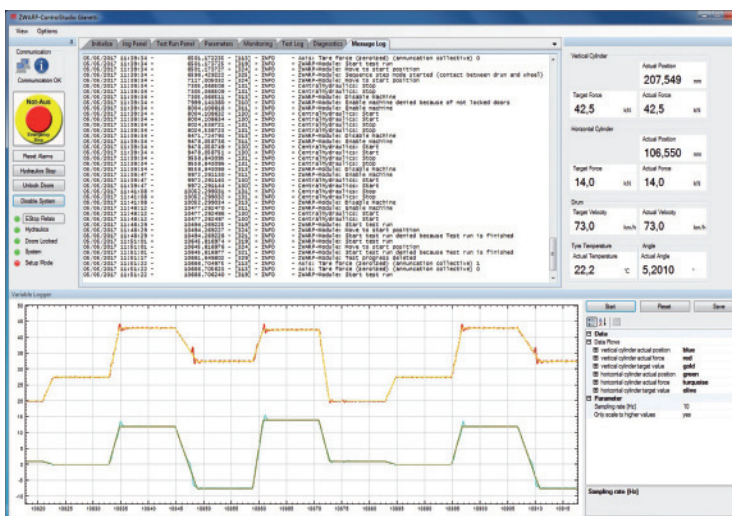

Message log

All system messages are notified as readable text with the time and date. This log is important for maintenance. All messages are also recorded in the log file.

ZWARP user interfaces

Further competences

- **Information flow in the event of test interruption**
The test bench is halted immediately if the test object fails or other problems occur.
- **Test interface**
The test interface can be displayed on several computers in the same network if required. This makes it possible to follow the procedures on several screens.
- **Screen module**
The „windows“ can be enlarged individually or dragged onto a second screen.
- **Graphics**
It is possible to save the graphics on the screen as an Excel file.

ZWARP hardware

High-performance software and controls enable the precise mechanics in the test benches. However, these alone do not make the test bench ready for use. We also offer the required hardware and expertise for test bench engineering.

The manufacturing of test benches is the high-end segment of hydraulic drive technology. Innovation, knowledge of standard technology, great expertise in controls and regulation technology, high-speed electronics and the mastery of mechanics allow us to manufacture high-performance test benches. We cooperate with experienced partners for safety and drive controls.

Our aim is to take on the necessary engineering work, as well as responsibility and supply, so that the test bench is ready for use after delivery. We see ourselves as a partner for total solutions in test bench engineering.

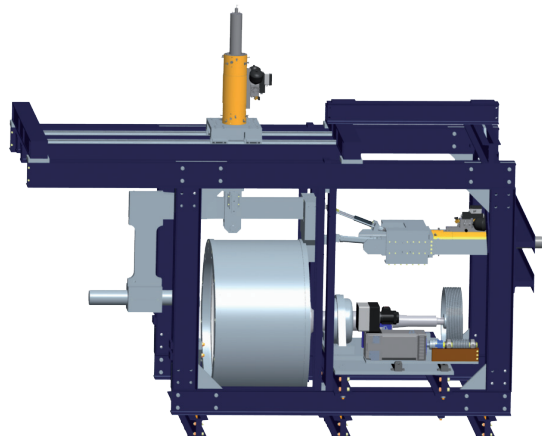

Servo cylinder

Model:	Double rod cylinder
Rod diameter:	160 mm
Bar diameter:	100 mm
Lift:	400 mm
Operating pressure:	max. 280 bar
Force:	+/- 250 kN at 210 bar
Lifting speed:	< 800 mm/s
Piston rod bearings:	hydrostatic
Piston rod:	hard chromium-plated steel or ceramic coating
Regulation valve:	Parker, directly operated, NG10
Position measurement:	MTS, output SSI, 24 Bit, Gray Code
Force measurement:	Interface, load cell on piston rod, 250 kN
Pressure measurement:	Pressure sensors at A and B, 0-400 bar
Fixing:	Flange
Installation position:	Horizontal or vertical
Ambient temperature:	-10 to +35 degrees Celsius
Medium:	Mineral oils HL or HLP according to DIN 51524, ISO VG-46
Sealing materials:	NBR, Teflon

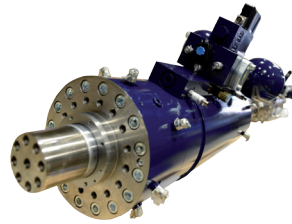

Controls cabinet

The controller concept is based on a very high-performance master, in combination with the ultra-high-speed fieldbus system GinLink. A 2.2 GHz Power PC CPU with 4 cores (actually with four processors) makes the controls extremely flexible. The 4-core architecture with a high processing power enables the parallel distribution of the real-time tasks over the 4 individual processors. The great flexibility of the system is achieved through the fieldbus system GinLink. With up to 256 fieldbus nodes, the controls can be perfectly decentralized and adapted to the application.



Aggregate

The heart of the aggregate is a KPM pump with various output volumes. According to the required pressure ranges, the volume flows are from 90 to 400 litres per minute. The axial piston pump regulates the mechanically set pressure (adjusting screw) and adapts the volume flow automatically. An additional block with a switchable pressure limitation enables the switching to a pressure-free circulation and at the same time safeguards the pump against overpressure.

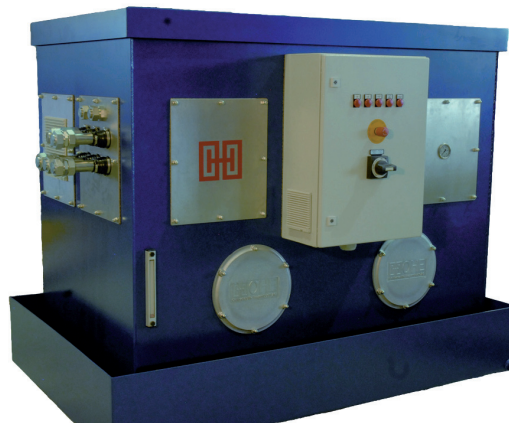

The world of hydraulic drive technology

From hydraulics engineers to systems engineers with 60 years of experience. Although our success story stems from oil hydraulics, our growth and international orientation are a result of our corporate concept, which is based on an integral approach.





Hydraulic drives are complex systems, which require high-quality components, as well as sophisticated mechanics and well thought out controls. In order to meet the demand for overall solutions, we have built up our own development and, alongside the manufacturing of components and aggregates, we have also specialised in the fields of mechanics, electrics and controls.

Today we are therefore a centre of excellence for components and drive systems of medium to high complexity and a worldwide supplier of innovative total solutions. OHE plans and develops customer-orientated solutions for sophisticated tasks, supplies all the elements from a single source and puts systems into operation all around the world.

As a supplier for a wide range of companies in a variety of machine industry sectors at home and abroad, we cover the following key areas:

- Conceptualisation of hydraulic drives with cylinders and aggregates
- Equipment for test machines in the automobile and aeronautical industry
- Production facilities for the paper and steel industry
- Drive concepts for the leisure industry
- Supply of special components for all investment goods areas
- Accessories for water power and energy technology
- Drive concepts for passenger transport
- Simulation concepts for the film industry
- All-round service for hydraulics

ZWARP references

- Accuride Corporation, Evansville - USA 
- BPW Bergische Achsen KG, Wiehl - Germany 
- Fraunhofer-Institut für Betriebsfestigkeit LBF, Darmstadt - Germany 
- Gianetti Ruote s.r.l., Ceriano Laghetto - Italy 



Hagenbuch Hydraulic Systems AG, Rischring 1, CH-6030 Ebikon, Tel. +41 (0)41 444 12 00, Fax +41 (0)41 444 12 01

info@hagenbuch.ch
www.hagenbuch.ch

HAGENBUCH 
Hydraulic Systems

201809/V02/E